

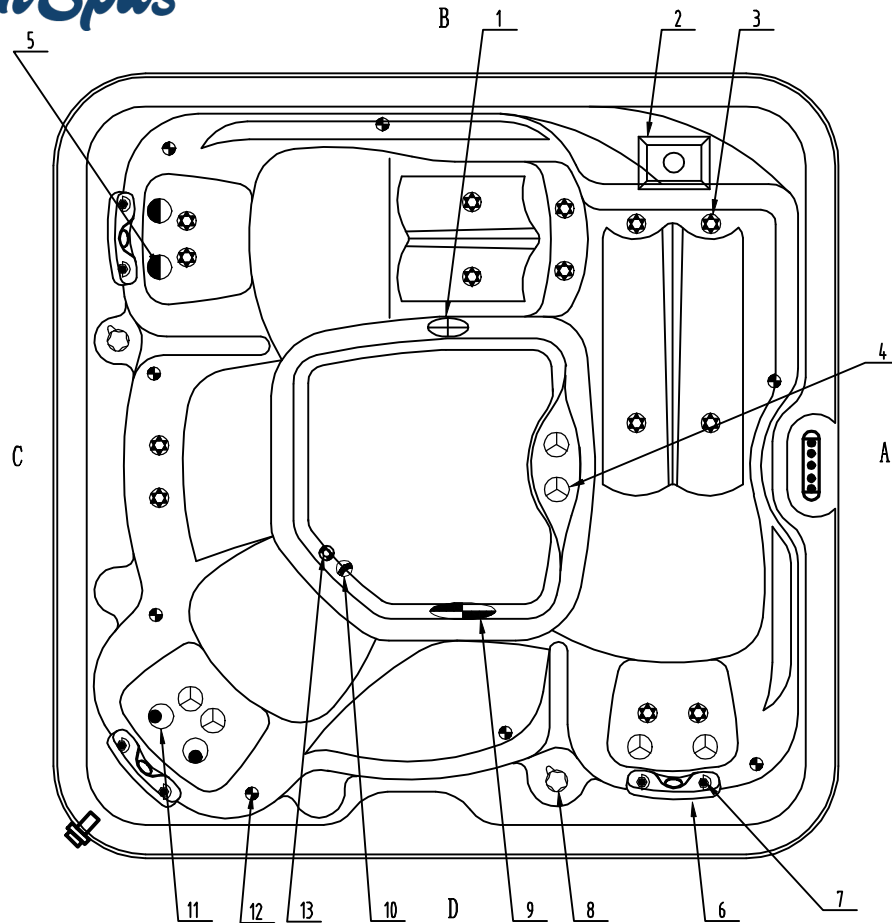

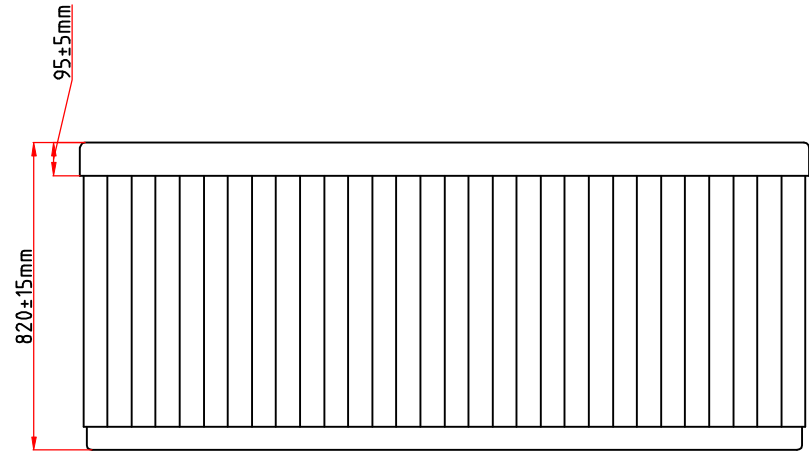

Notes: Due to manufacturing tolerances, there could be some minor differences between the actual spa and the drawing above. If site planning is critical to such tolerances, be sure to measure your actual spa. All specifications are subject to change without notice. Some components may be optional on your spa.

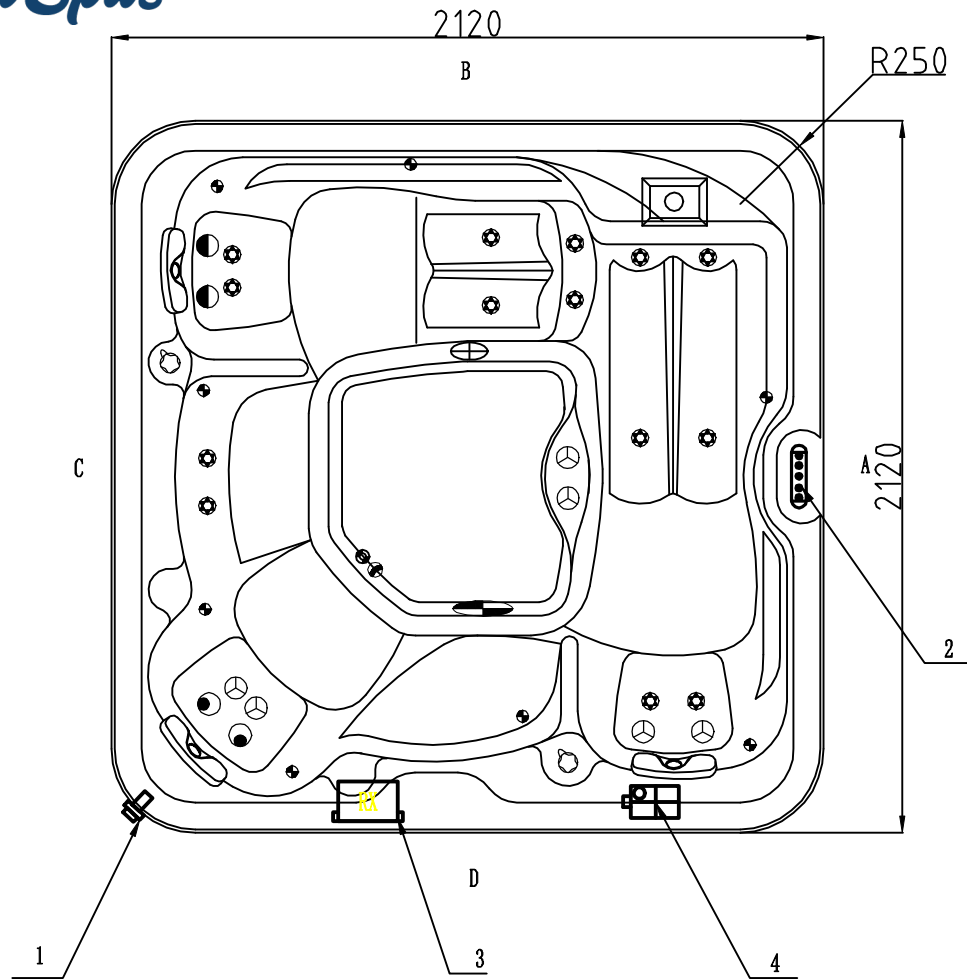

Notes: Due to manufacturing tolerances, there could be some minor differences between the actual spa and the drawing above. If site planning is critical to such tolerances, be sure to measure your actual spa. All specifications are subject to change without notice. Some components may be optional on your spa

13		Ozone Nozzle(Standard Grey)	01.03.03.0129	1	pc
12		MINI-LED light cover	01.03.03.0066	8	pc
11		4" Jet Internal-Single Pulse	01.03.04.0358	2	pc
10		Stainless Steel Low Drain - 3/4" Slip	01.03.04.0099	1	pc
9		5" Light Housing Without Holder	01.03.03.0108	1	pcs
8		1" Air Check Valve Assembly	01.03.04.0349	2	pcs
7		Headrest buckle with plastic nut	01.03.03.0497	6	pc
6		EVA Headrest-Butterfly	01.03.03.0878	3	pc
5		3" Jet Internal-Single Pulse	01.03.04.0357	2	pc
4		3" Jet Internal-Directional	01.03.04.0354	6	pc
3		2" Jet Internal-Directional	01.03.04.0353	14	pc
2		Single cylinder skimmer	01.03.04.0340	1	pcs
1		2" Suction (full set) - SS Face	01.03.03.0228	1	pc
NO.	Icon	Description	Part #	Qty	Unit



4		2.5HP Double Speed Pump	01.05.01.0497	1	pc
3		Control Box	01.03.05.0608	1	pc
2		Control Panel	01.03.05.0198	1	pc
1		Drain Valve	01.03.03.0450	1	pc
NO.	Icon	Description	Part #	Qty	Unit

Notes: Due to manufacturing tolerances, there could be some minor differences between the actual spa and the drawing above. If site planning is critical to such tolerances, be sure to measure your actual spa. All specifications are subject to change without notice. Some components may be optional on your spa.