

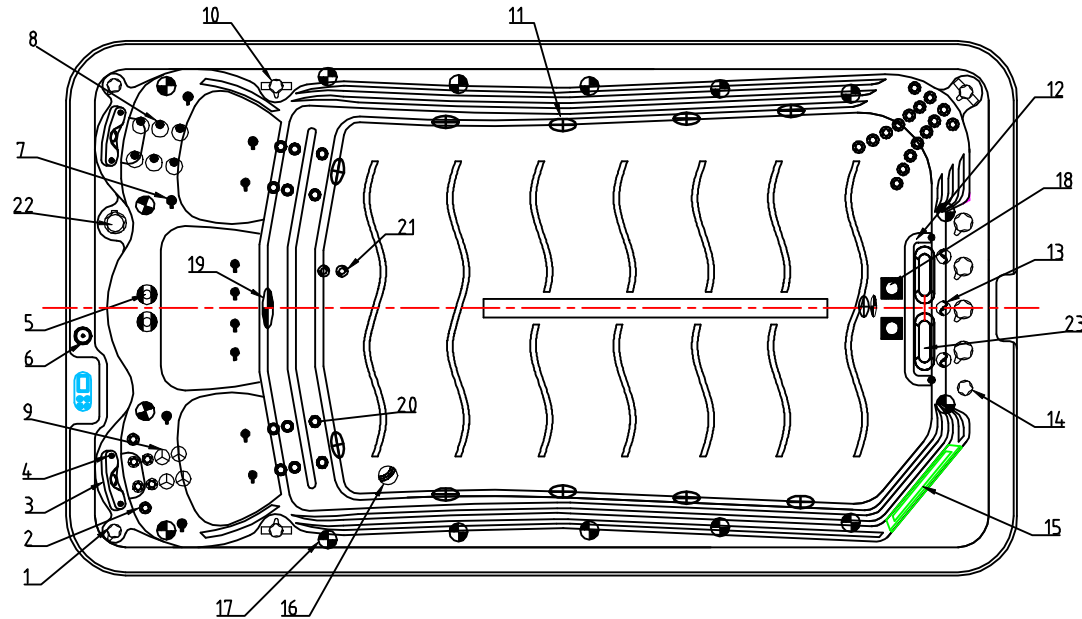





























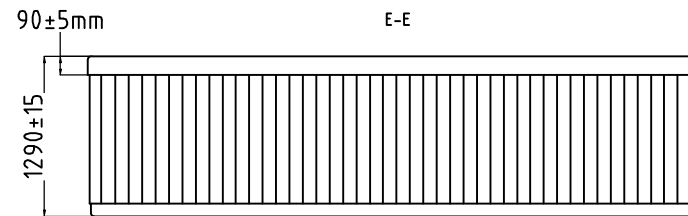
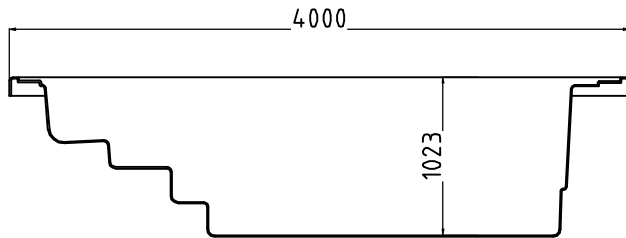
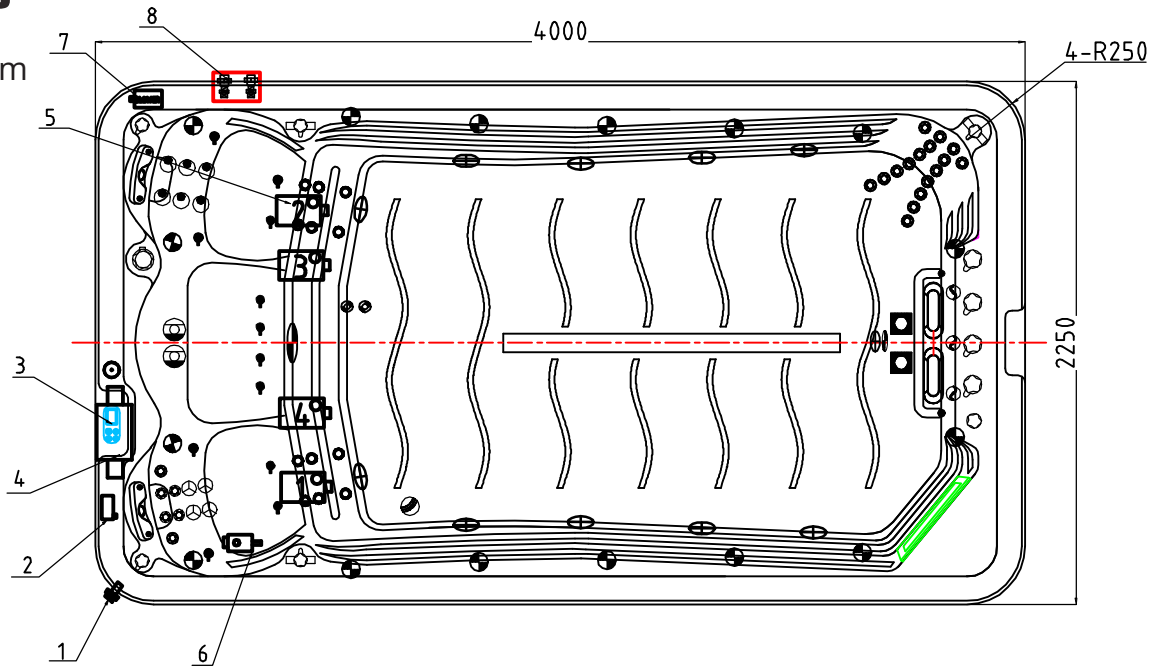

Notes: Due to manufacturing tolerances, there could be some minor differences between the actual spa and the drawing above. If site planning is critical to such tolerances, be sure to measure your actual spa. All specifications are subject to change without notice. Some components may be optional on your spa.



						12		Stainless steel Handrail	01.03.06.0054	1	pc
23		River Stream Swim Jet	01.03.04.0106	2	pc	11		2" Suction (full set) - SS face	01.03.03.0228	8	pcs
22		Aromatherapy	01.03.04.0326	1	pcs	10		2" Water diverter valve	01.03.03.0660	3	pcs
21		Ozone Injector	01.03.03.0129	2	pc	9		3" Jet internal-Directinal	01.03.04.0159	4	pc
20		Large 1" Direct Jet Internal	01.03.04.0075	12	pc	8		4" Jet-Single Spin	01.03.04.0162	6	pc
19		5" Light housing without Holder	01.03.03.0108	2	pcs	7		1" air injector assembly	01.03.04.0076	12	pc
18		Swim jet - Force 10	01.03.04.0130	2	pcs	6		stainless steel swim base	01.03.06.0189	1	pc
17		MINI-LED light cover	01.03.03.0066	16	pc	5		5" Jet-Twin Spin	01.03.04.0165	2	pc
16		Star-Shape SS Bottom Drain	01.03.04.0099	1	pc	4		Headrest buckle with plastic nut	01.03.03.0497	4	pc
15		Twin Cilinder Skimmer	01.03.03.0737	1	pcs	3		Butterfly Headrest	01.03.03.0748	2	pcs
14		Fountain Valve	01.03.03.0658	1	pcs	2		2" Jet Internal-Directional	01.03.04.0158	22	pc
13		Roma fountain	01.03.04.0129	3	pcs	1		1" Air Check Valve Assembly	01.03.03.0659	6	pcs
NO	ICON	DESCRIPTION	PART #	QTY	UNIT	NO	ICON	DESCRIPTION	PART #	QTY	UNIT

Notes: Due to manufacturing tolerances, there could be some minor differences between the actual spa and the drawing above. If site planning is critical to such tolerances, be sure to measure your actual spa. All specifications are subject to change without notice. Some components may be optional on your spa.







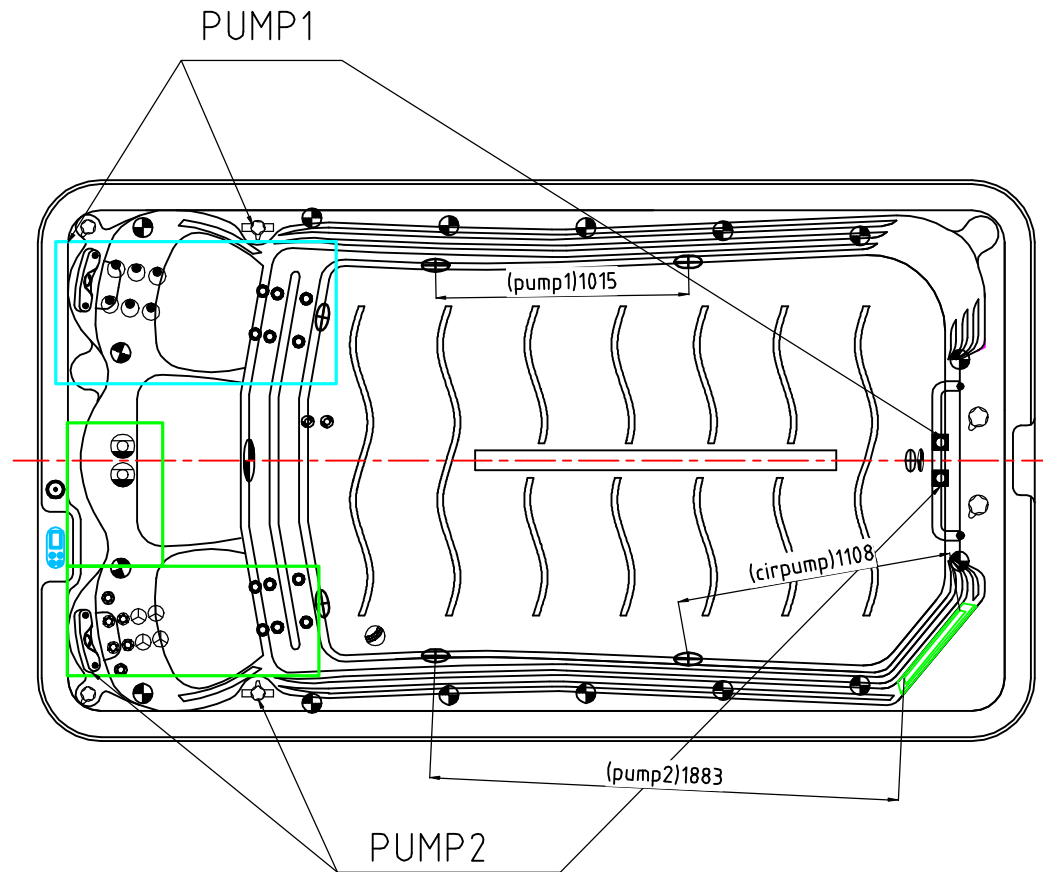



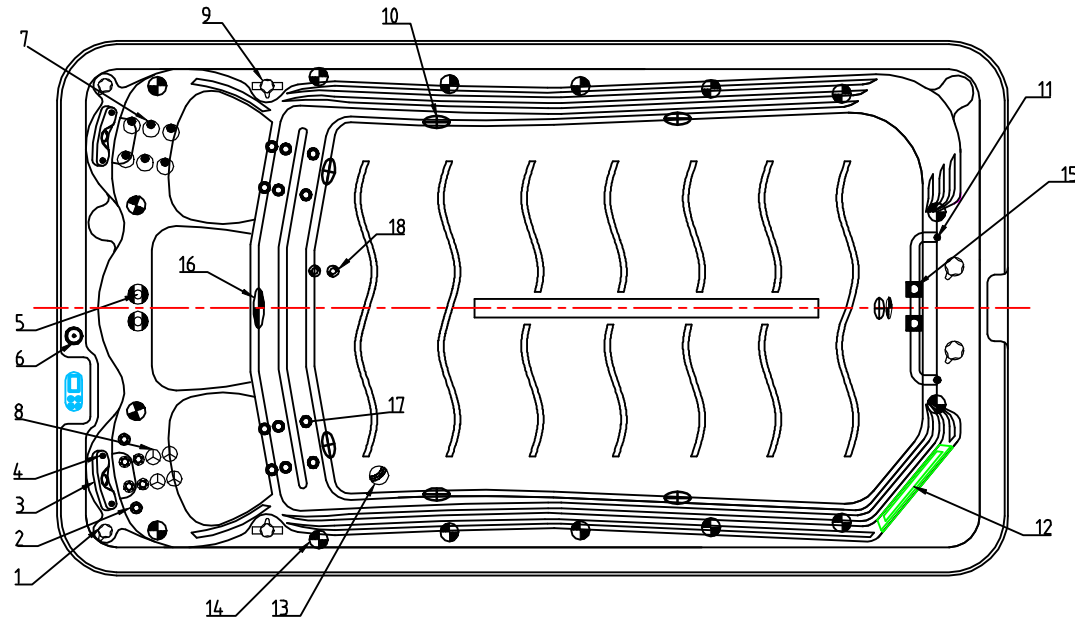



8		Heat Pump Ready Union		1	pc
7		Blower	01.03.05.0419	1	pcs
6		Circulation Pump	01.03.05.0525	1	pcs
5		3HP Single Speed Pump	01.03.05.0552	4	pc
4		Control Box	01.03.05.0131	1	pc
3		Control Panel	01.03.05.0134	1	pc
2		CP Ozone Generator	01.03.05.0035	1	pcs
1		Drain Valve	01.03.03.0450	1	pc
NO	ICON	DESCRIPTION	PART #	QTY	UNIT
			Edition:17/07/2018	ZC.AS55.0001	







Note: Due to manufacturing tolerances, there could be some minor differences between the actual spa and the drawing above. If site planning is critical to such tolerances, be sure to measure your actual spa. All specifications are subject to change without notice. Some components may be optional on your spa.



Notes: Due to manufacturing tolerances, there could be some minor differences between the actual spa and the drawing above. If site planning is critical to such tolerances, be sure to measure your actual spa.
All specifications are subject to change without notice.
Some components may be optional on your spa.



12		Twin Cylinder Skimmer	01.03.03.0737	1	pcs
11		Stainless steel Handrail	01.03.06.0054	1	pc
10		2" Suction (full set) - SS face	01.03.03.0228	4	pcs
9		2" Water diverter valve	01.03.03.0660	2	pcs
8		3" Jet internal-Directinal	01.03.04.0159	4	pc
7		4" Jet Single-Spin	01.03.04.0162	6	pc
6		stainless steel swim base	01.03.06.0189	1	pc
5		5" Jet Twin-Spin	01.03.04.0165	2	pc
4		Headrest buckle with plastic nut	01.03.03.0497	4	pc
3		Butterfly Headrest	01.03.03.0748	2	pcs
2		2" Jet Internal-Directional	01.03.04.0158	6	pc
1		1" Air Check Valve Assembly	01.03.03.0659	4	pcs

18		Ozone Injector	01.03.03.0129	2	pc
17		Large 1" Direct Jet Internal	01.03.04.0075	12	pc
16		5" Light housing without Holder	01.03.03.0108	2	pcs
15		Swim jet - Force 10	01.03.04.0130	2	pcs
14		MINI-LED light cover	01.03.03.0066	16	pc
13		Star-Shape SS Bottom Drain	01.03.04.0099	1	pc

Notes: Due to manufacturing tolerances, there could be some minor differences between the actual spa and the drawing above. If site planning is critical to such tolerances, be sure to measure your actual spa. All specifications are subject to change without notice. Some components may be optional on your spa.

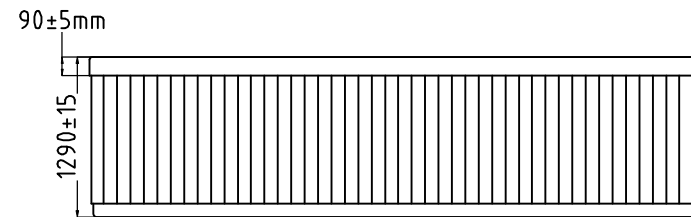
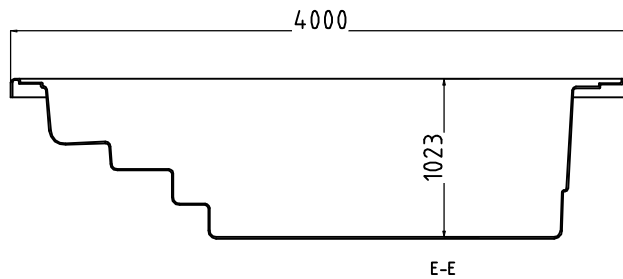
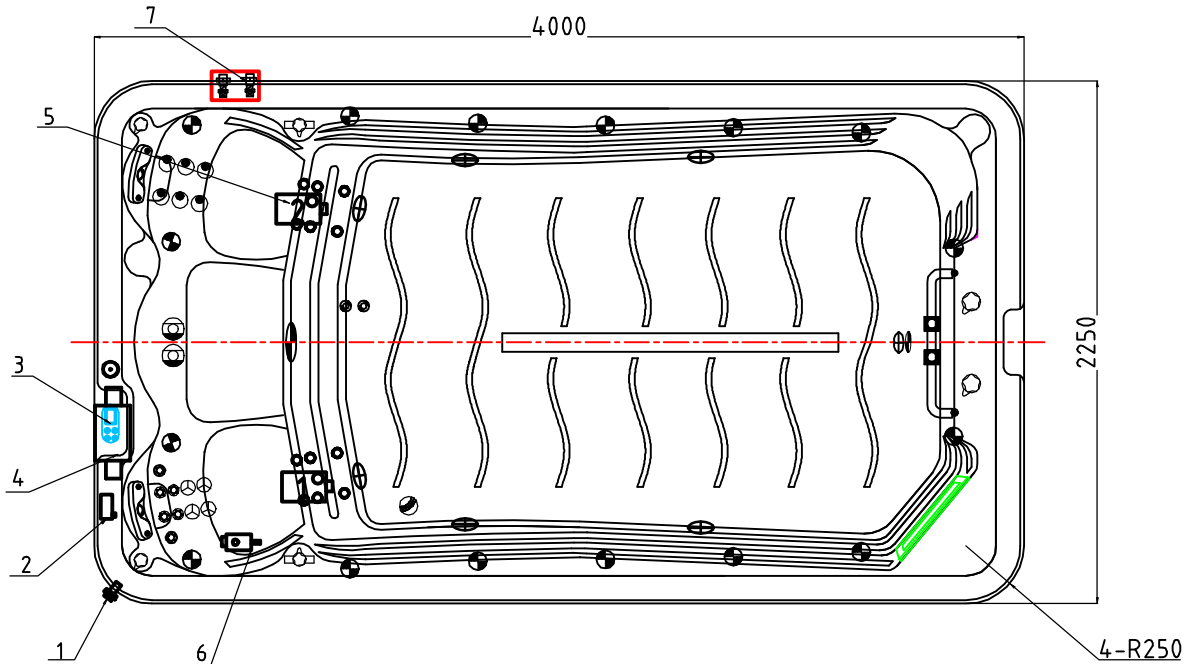





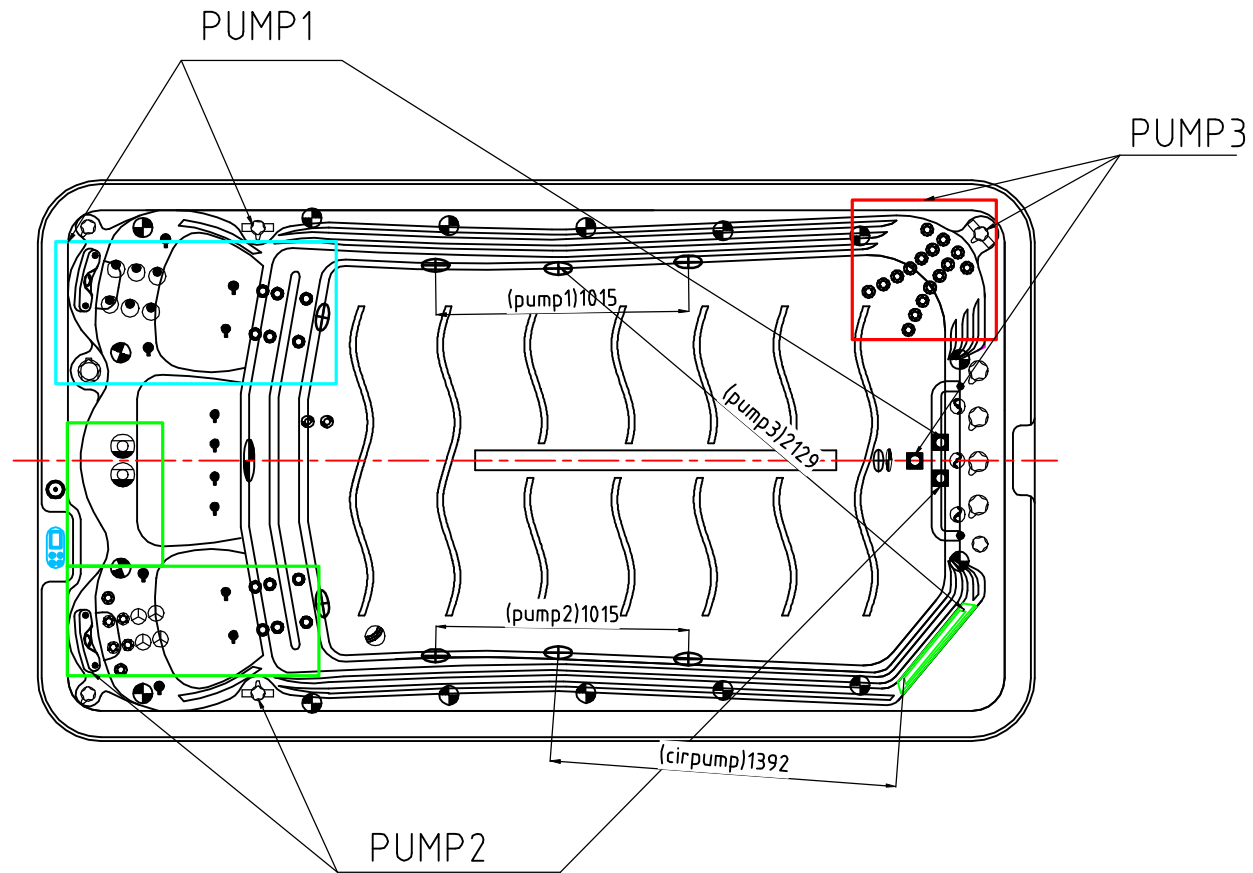



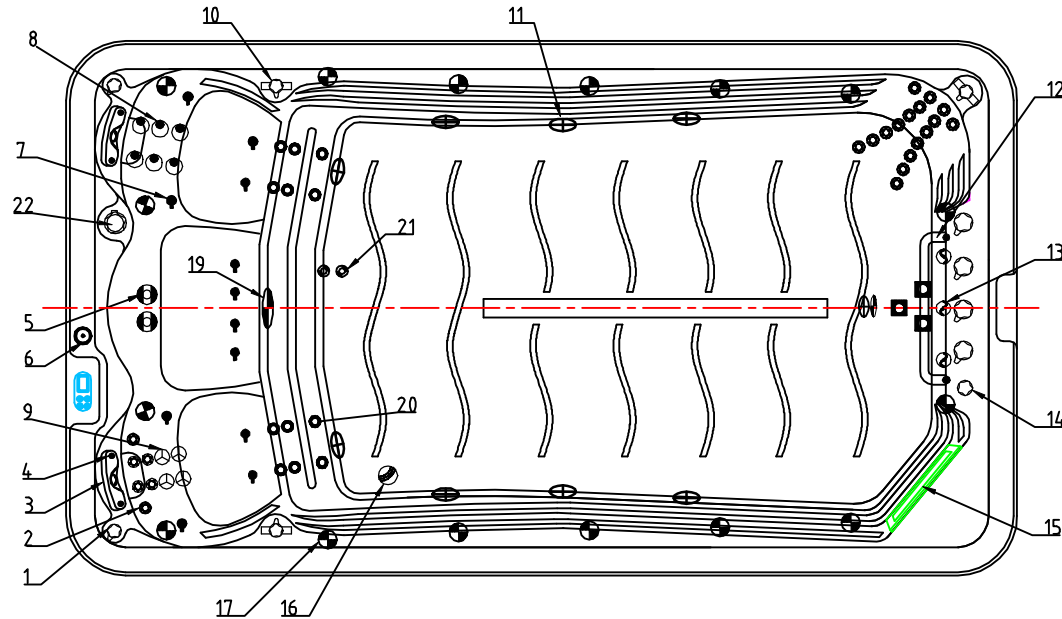













7		Heat Pump Ready Union		1	pc
6		Circulation Pump	01.03.05.0525	1	pcs
5		3HP Single Speed Pump	01.03.05.0552	2	pc
4		Control Box	01.03.05.0130	1	pc
3		Control Panel	01.03.05.0133	1	pc
2		CP Ozone Generator	01.03.05.0035	1	pcs
1		Drain Valve	01.03.03.0450	1	pc
NO	ICON	DESCRIPTION	PART #	QTY	UNIT
			Edition:17/07/2018	ZC.AS40.0003	

Notes: Due to manufacturing tolerances, there could be some minor differences between the actual spa and the drawing above. If site planning is critical to such tolerances, be sure to measure your actual spa. All specifications are subject to change without notice. Some components may be optional on your spa.



Notes: Due to manufacturing tolerances, there could be some minor differences between the actual spa and the drawing above. If site planning is critical to such tolerances, be sure to measure your actual spa. All specifications are subject to change without notice. Some components may be optional on your spa.



						12		Stainless steel Handrail	01.03.06.0054	1	pc
						11		2" Suction (full set) - SS face	01.03.03.0228	6	pcs
22		Aromatherapy	01.03.04.0326	1	pcs	10		2" Water diverter valve	01.03.03.0660	3	pcs
21		Ozone Injector	01.03.03.0129	2	pc	9		3" Jet internal-Directinal	01.03.04.0159	4	pc
20		Large 1" Direct Jet Internal	01.03.04.0075	12	pc	8		4" Jet-Single Spin	01.03.04.0162	6	pc
19		5" Light housing without Holder	01.03.03.0108	2	pcs	7		1" air injector assembly	01.03.04.0076	12	pc
18		Swim jet - Force 10	01.03.04.0130	3	pcs	6		stainless steel swim base	01.03.06.0189	1	pc
17		MINI-LED light cover	01.03.03.0066	16	pc	5		5" Jet-Twin Spin	01.03.04.0165	2	pc
16		Star-Shape SS Bottom Drain	01.03.04.0099	1	pc	4		Headrest buckle with plastic nut	01.03.03.0497	4	pc
15		Twin Cilinder Skimmer	01.03.03.0737	1	pcs	3		Butterfly Headrest	01.03.03.0748	2	pcs
14		Fountain Valve	01.03.03.0658	1	pcs	2		2" Jet Internal-Directional	01.03.04.0158	22	pc
13		Roma fountain	01.03.04.0129	3	pcs	1		1" Air Check Valve Assembly	01.03.03.0659	6	pcs
NO	ICON	DESCRIPTION	PART #	QTY	UNIT	NO	ICON	DESCRIPTION	PART #	QTY	UNIT

Notes: Due to manufacturing tolerances, there could be some minor differences between the actual spa and the drawing above. If site planning is critical to such tolerances, be sure to measure your actual spa. All specifications are subject to change without notice. Some components may be optional on your spa.

4.0 Pro Platinum

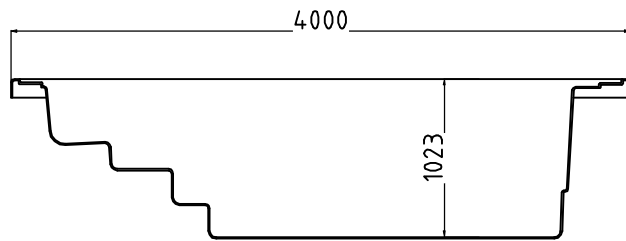
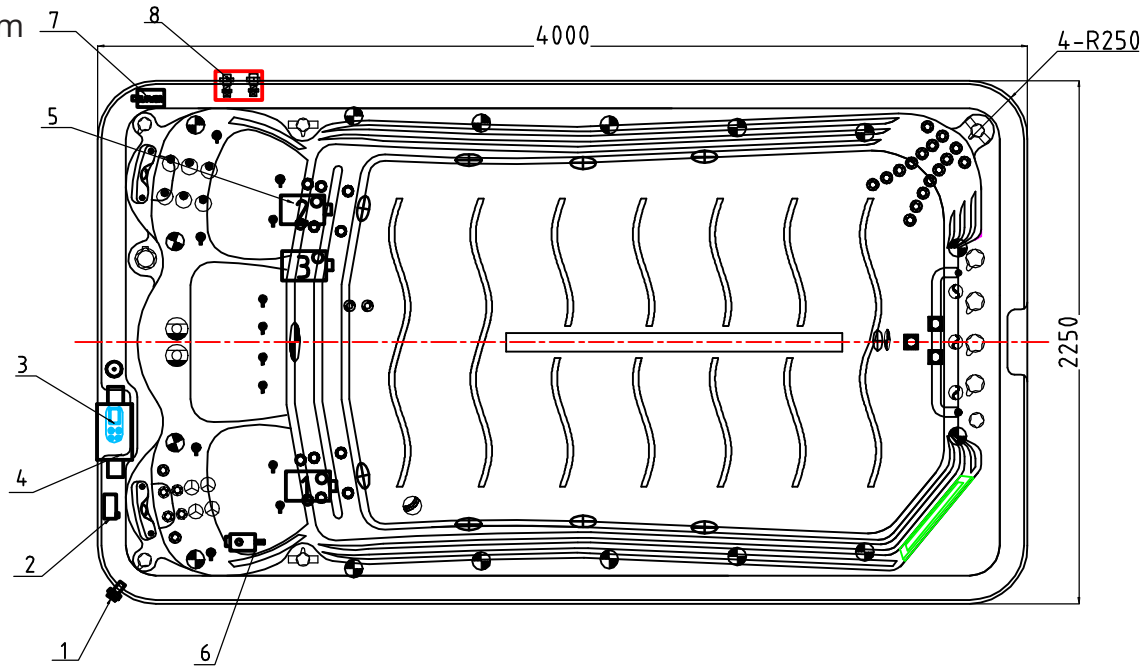

E-E

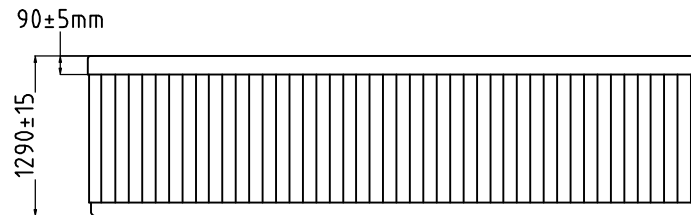

8		Heat Pump Ready Union		1	pc
7		Blower	01.03.05.0419	1	pcs
6		Circulation Pump	01.03.05.0525	1	pcs
5		Single Speed Pump	01.03.05.0552	3	pc
4		Control Box	01.03.05.0130	1	pc
3		Control Panel	01.03.05.0133	1	pc
2		CP Ozone Generator	01.03.05.0035	1	pcs
1		Drain Valve	01.03.03.0450	1	pc
NO	ICON	DESCRIPTION	PART #	QTY	UNIT
			Edition:17/07/2018	ZC.AS40.0002	

Notes Due to manufacturing tolerances, there could be some minor differences between the actual spa and the drawing above.
If site planning is critical to such tolerances, be sure to measure your actual spa.
All specifications are subject to change without notice.
Some components may be optional on your spa.